

TSS and TSS-IL

Suspended Solids Sensor



- Following Customer feedback we have changed the hot-tap locking mechanism of the TSS-IL:
 - ❑ The lock-nut (1) have been changed to a left-hand thread, to prevent accidental loosening of the pressure seal nut (2) when removing the TSS-IL.
 - ❑ These two nuts are now also differently sized to avoid confusion.

This change was implemented january 2021



TABLE OF CONTENTS

1. Introduction	3
2. A few words about this manual	3
3. Design	3
4. Measuring principle	3
5. Unpacking the Sensor	4
6. Mounting	5
Cable Connections.....	5
Submersible sensor TSS	5
Installation Tips	5
Inline sensor TSS-IL	6
7. Removing the sensor	9
Removing the submersible sensor TSS	9
Removing the Inline sensor TSS-IL.....	9
8. Cleaning	10
Flushing Nozzle on submersible sensors.....	11
Flushing Nozzle on inline sensors.....	11
Mounting plate for cleaning solenoid valves.....	11
9. Menu for TSS sensor	12
10. Calibration	14
Calibration points	14
Negative values	14
Calibration screen.....	15
Automatic adjustment of the calibration	16
Getting good measurement.....	16
Zero Calibration	17
Calibration with samples	17
11. Scaling	18
12. Sensor display	18
13. Technical description	19
TSS 20	19
TSS- IL 15/34	19
14. Dimensions	21
TSS 20	21
TSS-IL 15/34	21
Appendix 1, Assembly of handrail mounting kit	22
Appendix 2, Assembly of adjustable slide rail	23
Appendix 3, Assembly of TSS-IL	24
Appendix 4, Support information	25
Appendix 5, Setup information	27

1. Introduction

The TSS sensor is designed to measure suspended solids concentrations in liquids. Combined with the BB2 control box, the sensor is used to measure suspended solids content as a function of the ability of suspended materials to absorb and reflect NIR-light (Near Infra-Red). The sensor is available in two versions; for inline mounting and for submersion.

2. A few words about this manual

This manual details installation procedures and operational features of the Cerlic TSS sensors. Menu navigation and technical data for the BB2 control box can be found in the BB2 service manual.

3. Design

The TSS sensor is manufactured with 316SS (SS2343) stainless steel. The head of the sensor is designed to achieve the highest self-cleaning effect, providing an exact and reliable measurement with the least possible maintenance under critical applications. The measuring lenses within the housing are made of glass. The electronics and optics are protected in the rugged casing, ensuring its reliability in very demanding environments.

TSS has a fixed, shielded 10 m (33") cable used for signal transmission between the sensor and the BB2 control box. The cable sheath is made of Hytrel and is highly resistant to aggressive materials and fluids. TSS-IL has a M12 connector to connect a standard cable to the BB2 control box.

4. Measuring principle

The TSS measures transmitted light through the liquid. The measuring principle is based on the suspended particles ability to absorb and reflect NIR (Near Infra-red) light. The light source is a light emitting diode that pulses and emits monochromatic light with a wavelength of 880 nm. The detected measuring signal is inversely logarithmical proportional to the consistency or suspended solids. Signal treatment or linearization is done within the BB2 control box. The temperature is measured by the transmitter to be used for temperature compensation of the measured value. It can be read in the BB2 box, and used as secondary value when a transmitter is configured to use both analog outputs of the BB2. The temperature is not a precision measurement, but shall be seen as an indication. TSS 20 measures the temperature on the electronics board where it is always some degrees higher than in the media.

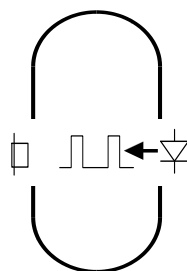

Cross-section of measuring gap.

5. Unpacking the Sensor

The unit has been tested and approved before delivery from the supplier. Please check to confirm that no visible damages occurred during shipment.

Damages

If damages occurred during shipment, immediately contact UPS or other truck line as well as your Cerlic representative. The shipment can be returned only after contact has been made with Cerlic.

Packaging

The original packaging is designed to protect the equipment and should be used for storage or if the goods must be returned.

Content

Please check that the content corresponds to your order and packing list. Every shipment should include:

Options and accessories

	P/N
• Solenoid valve for flushing Incoming hose Ø16mm (5/8") , to sensor Ø 8mm (1/3")	1705516
• Aluminum mounting plate predrilled for BB2 and solenoid valves w/ u-bolts,	US version 31204054 outside US version 10605532
• 10m extension cable with plug-in connectors.	20805510
• Connection box for two sensors to one BB2 control box with 1m (3 ft) cable to connect to BB2	11505748
• Connection box for four sensors to one BB2 control box with 1m cable to connect to BB2	11505785

Optional parts for TSS Submersion sensor:

• Mounting bracket X, incl. rod holder	11205539
• Telescopic rod, 4 m, incl. transmitter holder	20205501
• Adjustable slide rail	11205600

Optional parts for TSS-Inline sensor:

• Connection valve TSS-IL excl. nipple	11205631
• Weld end nipple	11205882
• 1 1/2" NTP nipple	20305158
• Sealing kit	10605708
Flush membrane	
O-ring between valve and adapter 48 x 2 EP70	
O-ring in the adapter 33.3 x 2.4 EP70	
O-ring on TSSIL 29 x 2.5 EP70	

6. Mounting

Cable Connections

Connect the sensor to the BB2 control box using the attached connector on the end of the sensor cable. In the event that two sensors are to be connected to the same BB2 control box, use the Y-splitter.

NOTE! Never try to turn the connector housing to fasten or remove the connector, only the fluted ring at the top of the connector shall be turned.

Submersible sensor TSS

The TSS is mounted on a telescopic fiberglass rod and placed in a mounting bracket that fastens to a handrail. Please refer to Appendix 1. As an alternative way of mounting the sensor, an adjustable slide rail holder is available; please refer to the Appendix 2 for further details.

When the sensor is measuring in a flume, it is important to find a place where the suspended solids concentration is representative.

Make sure the flushing nozzle is downstream from the lenses pointing against the stream. This will avoid having the measurement disturbed by turbulence from the nozzle. At the same time it will produce a shield around the nozzle, due to a constant over pressure, preventing particles from getting in.

Installation Tips

- Adjust the rod so that the sensor is at least 30 cm (12”) below the liquid surface or the lowest water level in decant applications to prevent the sensor from coming out of the liquid.
- In an aeration tank, ensure that the sensor is not directly above a diffuser head. It should be on the backside of the rolling diffuser effect.
- Flushing may not be required if the tank is well agitated. To verify the need for flushing, remove the sensor from the liquid after it has been in the liquid for several days. Place the sensor in a bucket of clean water and note the concentration value. If the value does not get close to zero, then the flush system should be utilized.
- When installing in a clarifier, compressed air flushing is required due to no agitation of liquid and to remove oil and grease film on lens. This is especially applicable in primary clarifiers.
- When using the TSS for influent applications, always install the unit after the bar screen. If the bar screen spacing is larger than 6 mm ($\frac{1}{4}$ ”), then a baffle or diffuser plate should be installed in front of sensor to prevent rags from catching on the sensor head. On influent applications, compressed air flushing is recommended due to the oil or grease in the liquid.
- In effluent applications a CTX type of sensor is recommended, it has better resolution at low concentrations.

Inline sensor TSS IL

TSS IL is mounted through a ball valve to make it possible to remove the sensor under pressure. Make sure there is at least 260 mm (10.5") free space to remove the sensor from the valve. The sensor shall be mounted in a place where the process pressure is at least 1 bar. In horizontal pipes the sensor shall be mounted from the side or from below to avoid disturbance from air bubbles.

The sensor is designed to be mounted in a right angle to the process flow. The smallest process pipe diameter to mount the sensor is 80mm (3"). The measure gap must be at least 5mm (1/4") from the pipe wall. If a sample outlet is used it must reach at least 20 mm (3/4") into the pipe.

Place the sensor where there is no risk for it to get damaged. When the TSS IL is used outdoor it shall be mounted with a sun and rain protective hood.

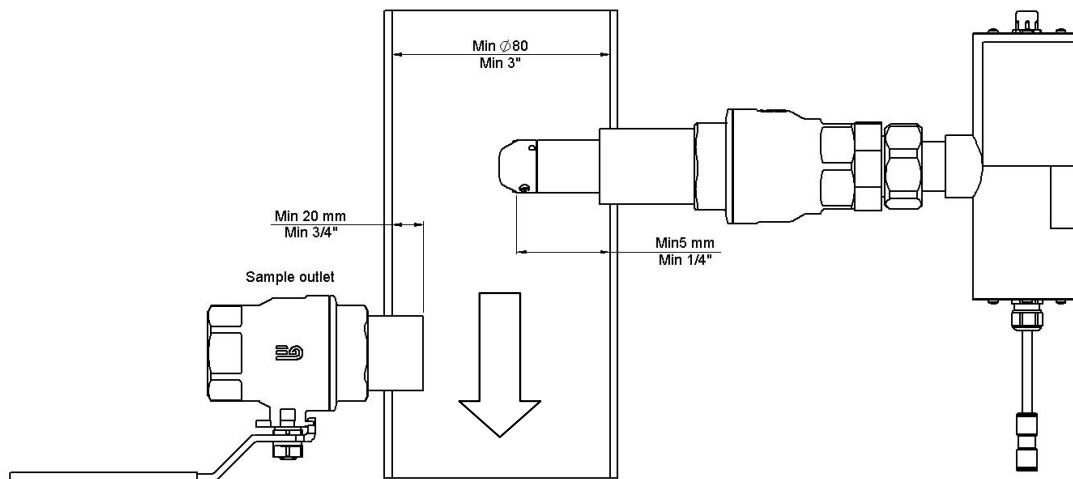

Mounting of sensor and sample outlet

Mounting the weld end

Open a $\varnothing 48,5$ mm (1.9") hole in the process pipe. Cut the weld end to get the sensor at head least 5 mm ($\frac{1}{4}$ ") from the pipe wall and weld it to the pipe. Stabilize the weld end using 3mm ($\frac{1}{8}$ ") strip iron according to the figure below.

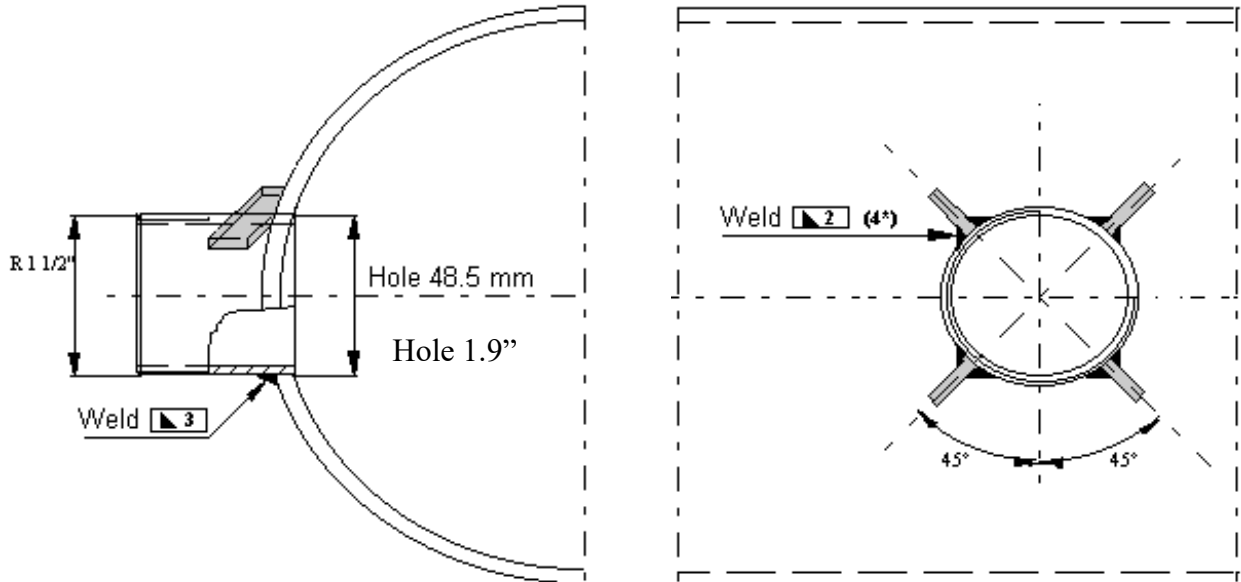

Mounting of weld end with strip iron

Mounting the threaded nipple in a saddle

Mount the saddle on the pipe according to the saddle manufacturer's instructions. Thread the Cerlic supplied SS nipple into the saddle. Nipple is $1 \frac{1}{2}$ " npt on saddle side and $1 \frac{1}{2}$ " BSPT on valve side. Use a lot of flaxen hair and joint paste to seal. Be aware to get the correct distance from the pipe wall to the valve which is 8".

Hot Tapping of pipe – use 39 mm Holw Saw Drill to drill hole into the pipe. Drill should go thru the valve and you will probably need extra nipple to have $1 \frac{1}{2}$ " npt threads at drill end. Contact Cerlic for nipple on back side of valve.

Mounting ball valve

Thread the valve end on the but weld end or nipple. Use a lot of flaxen hair and joint paste. Be aware not to pull the valve end to the bottom. The valve handle shall be in the correct direction as to the current pipeline. If the valve is turned the wrong way, the measure gap will not be in line with the flow, resulting in faulty measurement. The angle of the sensor can be adjusted $\pm 15^\circ$ when the sensor is put in place.

Mounting of sensor in ball valve

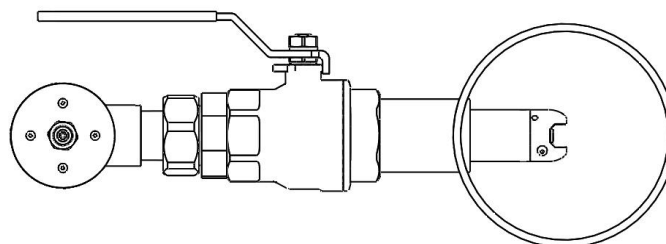

- Be aware that the force may be strong when the sensor is mounted under pressure.
- This instruction must be fulfilled in all parts to avoid accidents or personal damage.
- If the instructions cannot be fulfilled in all parts, the transmitter should not be mounted or dismounted under process pressure.
- Cerlic can not be responsible for accidents caused by not following these instructions

WARNING!

The sensor is mounted in the valve using an adapter. Make sure that the o-rings in the adapter between the sensor and the valve, and on the sensor, below the sensor nut, are OK. Use Silicon grease or soup to grease the O-rings before mounting the adapter. If the adapter is separated from the sensor, check and grease the O-ring inside the adapter then push the adapter over the sensor head having the smaller thread towards the sensor house.

The adapter serves two purposes

A thread for the sensor nut to keep the sensor in place. **Please note that the sensor nut is left threaded.**

A stop for the stop screw to prevent the sensor from coming lose when the left threaded sensor nut is loosened.

When tighten the sensor nut, one must hold the adapter so that it don't loosens. This is because that the sensor nut is left threaded. a word of advise, don't use to much force when tightening, because it will just make it harder to disassemble. Use only handforce and just a little bit more with a wrench.

Thread the adapter into the valve, the sensor is then fixed to the valve. When the adapter is tightened the valve can be opened, the sensor pushed in place, and the sensor nut screwed in place. If the process pressure is high, considerable force may be needed to push the sensor in place. Before the sensor nut is tightened the sensor must be aligned in parallel with the process flow.

WARNING!

- Be careful so that the transmitter is located straight. If the transmitter is not straight the transmitter can cut jam with damages on the transmitter or valve to follow.
- If the transmitter is hard to mount and you suspect something is stuck or that the transmitter is not mounted straight, crank out and check that everything is OK.
- The Left threaded Sensor nut can release big forces. Do not ever loose the nut without holding the sensor in place at the same time.

7. Removing the sensor

The sensor housing may not be opened except by Cerlic service personnel. Opening the sensor housing will void all warranty.

Removing the submersible sensor TSS

The sensor is removed in the following steps:

- Disconnect the sensor cable from the BB2 and the flushing hose from solenoid.
- Open the clamp, and pull the rod out of the mounting bracket
- Make sure all water inside the rod is drained.
- Clean the sensor and rod with a brush or clean cloth. Do not use a wire brush!
- Open the black sensor adapter.
- Flush the inside of the rod with clean water.
- Mount the protective cap (or a small plastic bag) on the sensor cable connector.
- Pull the cable and flushing hose out of the rod.
- Blow compressed air through the flushing hose to get rid of the water in the hose and the sensor.

Removing the Inline sensor TSS-IL

The sensor is removed in the following steps:

- Loosen the left threaded sensor nut; make sure the adapter to the valve stays on the valve. Hold the sensor in place when the nut is removed; be aware considerable force may be needed to hold the sensor in place if the process pressure is high.
- Let the sensor out until it rests on the stop screw in the adapter.
- Close the valve.
- Disconnect the sensor cable and the flushing hose from the sensor. If the check valve inside the sensor is worn, some liquid may come out of the sensor hose.
- Loosen the adapter from the valve; be aware there is some liquid in the valve.
- Remove the sensor and the adapter (they stick together).
- Clean the sensor using a soft brush or a rag. Do not use a metallic brush or sharp tools!

8. Cleaning



The sensor is equipped with built-in flushing nozzles. The nozzles are used to direct the cleaning liquid or air through a 8mm (1/3") hose that is connected to the top of the sensor housing. A solenoid valve that is wired to an alarm relay in the BB2 control box controls the air or liquid. Water is recommended for flushing in aeration basins. Compressed air is recommended for most other applications.

For TSS submersible sensor the highest allowed flush pressure is 6 bar. When using air, 2 bar is usually sufficient.

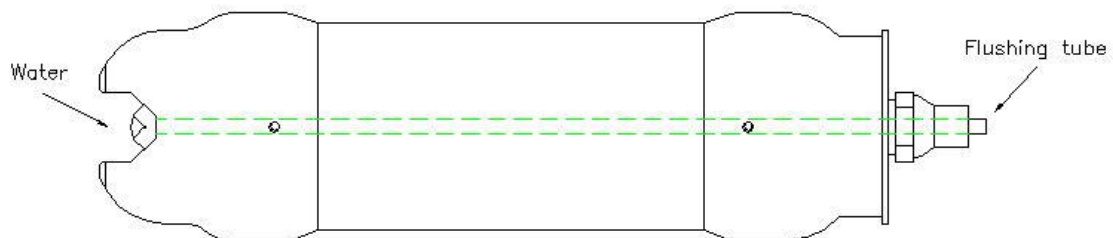
Inline sensors require a flushing pressure at least 2 bars above the process pressure, the highest allowed flushing pressure for TSS-IL is 8 bar.



Flushing must be activated in the “Settings” menu in the BB2 control box:

- Select the transmitter in the Main Menu by using the  or  buttons.
- Press ENTER for approximately five seconds to enter the Transmitter Menu.
- Use the arrows to select “Cleaning” and press ENTER.
- In the “Cleaning” submenu,
 - If the sensor is to be cleaned as master, i.e. it has its own relay, then set the “Cleaner” setting to “flush”, specify the cleaning interval in minutes, and the flush time in seconds. If the sensor is to be cleaned as a slave, along with another sensor, these parameters are set for the sensor being the master.
 - If needed, specify the extra freeze time in seconds.
 - If the sensor shall be cleaned as master, specify the relay to be used according to the wiring inside the control box. For example, if the solenoid is wired to relay #1, select “#1” for flushing. If the sensor is to be cleaned as a slave, specify “Along #1” or “Along #2” depending on what relay the master sensor uses.
 - For sensors configured as masters, “Next time” displays the next time flush will be activated, pushing ENTER will set it to current time and those start cleaning.

NOTE! Pay attention to the requirements for protection against backflow, according to the EN 1717 standard for drinking water devices. If possible, use plant reuse water or effluent water for cleaning.

Flushing Nozzle on submersible sensors

On sensors having a serial number starting with 10- or 11- the flushing nozzle and sensor cannot be disassembled in the field. An attempt to disassemble will void the warranty. On newer sensors the nozzle can be removed by opening the clamping screw next to the nozzle.

If the flushing nozzle becomes plugged, it can usually be cleaned by backflushing it with clean water. Before attempting to backflush, close the valve for the flush water source and disconnect the sensor flushing hose from the solenoid valve. Then, place a 12mm (½”) hose over the flush nozzle and carefully open the water valve. The pressure should clear the line of solids. If backflushing does not work initially, try cleaning the three flushing nozzles with a needle. Try backflushing the nozzles again as described above until clean water comes out at the solenoid valve end of the hose.



Flushing Nozzle on inline sensors

The nozzle of the Inline sensor works as a check valve to avoid having process liquid pressed up the flushing hose. The nozzle usually doesn't need to be cleaned. It consists of a rubber membrane held in place by a steel bracket. The bracket is attached to the sensor head with two screws; the screws are secured using soft thread retainer. If flushing is not used, the nozzle can be plugged by removing the bracket and the membrane, then fitting a spotfaced M5x8 screw with soft thread retainer in the hole.

Mounting plate for cleaning solenoid valves

To provide an easy mounting of solenoid valves for the built-in flushing nozzles Cerlic offers a predrilled Aluminum handrail mounting plate. The Mounting plate is fixed to the rail using two u-bolts.

9. Menu for TSS sensor

Use  or  to select the sensor in the main display. The menu for the selected sensor is accessed by pressing ENTER for five seconds. If the selected sensor is not active (the text **No transmitter** is shown) a warning is displayed that asks you to make another choice in order to show the sensor menu.

SETTINGS

Tag	Name of the sensor (10 characters) shown in the main display.
I-Time	Integration time or dampening - can be set up to 999 seconds
Unit	"%", "ppm", "g/l", or "mg/l"
Decimals	"Std" or "Extra". Number of decimals for the reading.
Analog	"None", "Out1", "Out2", "Out3", "Out4", "Out1+2", or "Out3+4". Pick which analog output(s) to be used with sensor
Second	"Temp" or "=Prim". If two are chosen above, the first will always give the primary value according to the sensors selected scale. The second will either give the temperature scaled 0-100°C, or the same signal as the first channel. The temperature is additional information, not a precision measurement.

CALIBRATE

Adjust	"No", "Store" or "Lab". Stores the reading of the meter when a sample is taken, and can then automatically adjust the sample value when the sample analyzed by lab is different to the reading.
Take sample	No, Zero, #1, n#2, #3, #4, #5. Sensor stores current MS (light) value in memory and you enter a lab solids value below to complete calibration.
Con	Current concentration, (same as shown in the main menu)
Sample #1	Lab test – consistency/suspended solids value for Sample 1
Sample #2	Lab test – consistency/suspended solids value for Sample 2
Sample #3	Lab test – consistency/suspended solids value for Sample 3
Sample #4	Lab test – consistency/suspended solids value for Sample 4
Sample #5	Lab test – consistency/suspended solids value for Sample 5

CLEANING

	Press ENTER to go to Cleaning program
Cleaner	"None", "Flush", or "Brush". Do not select "Brush" since this does not exist for this sensor (only for master)
Interval min	0-999 minutes, time between cleaning cycles (only for master)
Length sec	0-999 seconds, duration of flushing cycle (only for master)
Freeze sec	0-999 seconds, extra freeze time of output signal after a flushing cycle
Relay	"-", "#1", "#2", "Along #1", or "Along #2". Select relay to operate solenoid for flush cycle if this sensor is a master with its own relay, or relay used by master if this sensor is a slave. These are the same relays used for "Alarm relay" below
Next time	The next scheduled cleaning time. Pushing "Enter" on this line will set the time to current time and start a cleaning cycle. This could be used to test the "Flush" cycle. (only for master)

SCALE/ALARM

Max	0-99.9 % or 0-99999.9 ppm, mg/l, or g/l (units selected in the “Settings” menu), equal to 20 mA output signal.
Min	0-99.9 % or 0-99999.9 ppm, mg/l, or g/l (units selected in the “Settings” menu), equal to 4 mA output signal.
Hi-Alarm	0-99.9 % or 0-99999.9 ppm, mg/l, or g/l (units selected in the “Settings” menu) , the value zero inactivates the alarm
Low-Alarm	0-99.9 % or 0-99999.9 ppm, mg/l, or g/l (units selected in the “Settings” menu) , the value zero inactivates the alarm
Alarm Relay	”-” ”#1”, ”#2”, or ”#1 and #2”. Check that the relay is not being used for cleaning

SYSTEM

Type	Type of sensor, read only
Serial	Serial number of the sensor, read only
SoftW	Software version of the sensor, read only
Temp	Sensor temperature, read only
MaxTemp	The highest temperature the sensor has been exposed to, read only
Samples	Press “ENTER” to go to view SA values and consistency or suspended solids values.
SA 0	SA value for zero sample
SA 1	SA value for sample # 1
Cons 1	Lab test - consistency or suspended solids value for Sample # 1
....	SA and Cons repeated for samples 2 to 5
Info	Press “ENTER” to go to “info” read only menu. <u>This menu is for Cerlic internal use, it may change without notice</u>
MS	linearized light signal, which are SA values in calibration chart
Con	Unit value in %, ppm, mg/l, or g/l after MS value has been converted to units due to sample values. This is displayed on main screen
SA 0	SA value for zero sample
SA 1	SA value for sample # 1
Cons 1	Lab test - consistency or suspended solids value for Sample # 1
Ch1a	Raw value for channel 1
Ch1	Raw value for channel 1, compensated for changed intensity
Ch2	Raw value for channel 2
Intensity	Currently used intensity
Zero Int	Intensity for clear water, set during zero calibration
I-offset	Intensity offset, set during zero calibration
Samp/s	Number of samples per second
Service	Not accessible for users.

10. Calibration

The BB2 has a self-optimizing calibration algorithm/curve able to handle several calibration points in order to give maximum measuring precision in difficult applications. Usually however, a single point calibration is preferred. After a calibration has been carried out, make it a habit to look at the calibration curve in the sensor information screen to make sure it represents a smooth line without any sharp bends.

It is important that the instrument has been turned on for about 30 minutes prior to calibration so that the sensor and electronics can stabilize. Please check that the correct unit (consistency/suspended solids) is selected for the application. Select unit in the sensor menu “SETTINGS” – “UNIT”.

Calibration points

To calculate the consistency or concentration out of the loss of light the sensor uses a calibration curve. The curve is built up of the zero calibration point and at least one calibration point. Each point has a sample value and a consistency value. To be used a point needs both values, the sample value is set by “take sample” in the calibration menu, the consistency value is manually entered in the same menu after having analyzed the actual consistency at the time the sample was taken. A calibration point can be disabled by setting the consistency value to zero. In most applications one calibration point in addition to the zero sample is the best solution, adding more samples then just confuses the measurement. The only cases more than one calibration point is useful is when the measurement turns out to be non linear, or when the sensor needs to be very accurate at widely separated consistencies.

The zero calibration defines the zero point used as a reference for all other calibration points. The other points define the relation between loss of light and real consistency.

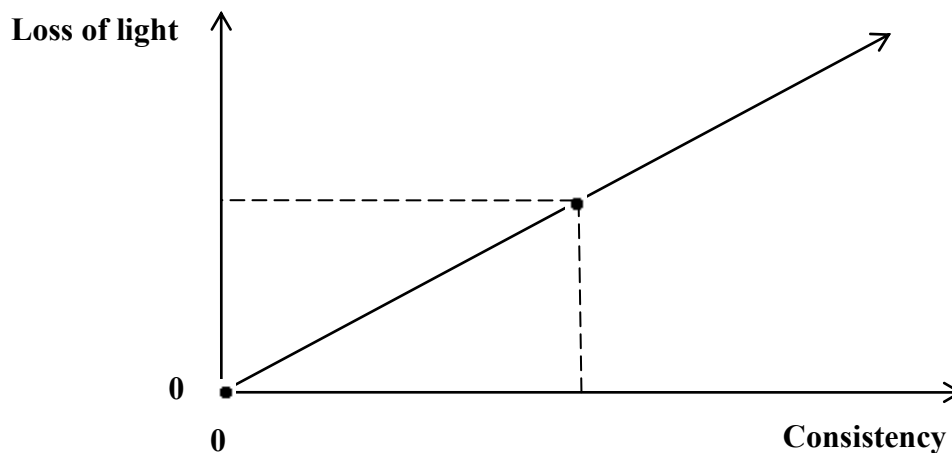

Negative values

The sensor continuously compares the loss of light to its calibrated points. If, for some reason, the loss of light is less than when the sensor was zero calibrated, the meter shows a negative consistency. This is not a fault, it just indicates the liquid in the sensor absorbs less

light than the liquid used as zero reference. Please contact Cerlic service if this is a problem for you.

Calibration screen

The TSS sensor information menu is the calibration curve screen. To change between the main menu and the calibration screen, press **↓** and ENTER simultaneously.

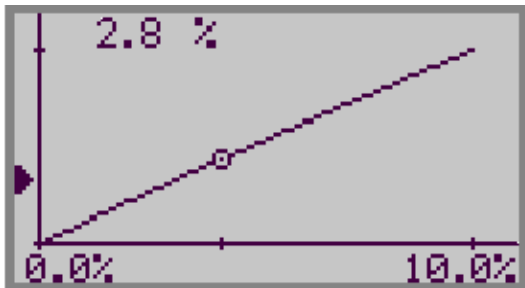

Single point calibration

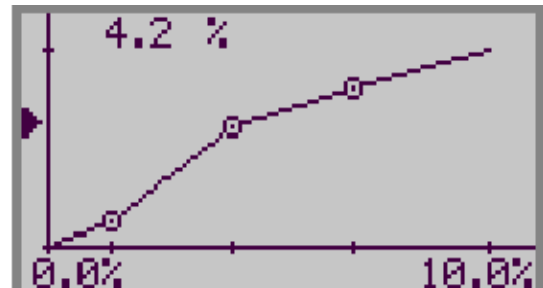

Multi point calibration

BB2 uses at least a zero sample and one sample (single point calibration). Up to five samples may be used to create a calibration curve (multi point calibration). The samples are sorted internally in order of signal intensity. The sample numbers however, doesn't change, only the order they are used. The calibration menu displays sample values placed in a graph.

- X-scale displays consistency/suspended solids, where **min** -value (4 mA output) is shown to the left and **max** -value (20 mA output) is shown to the right.
- Y-scale displays the light loss due to solids from the sensor light source. BB2 uses the light loss values to calculate which measuring signal corresponds to min-consistency/suspended solids and max-consistency/suspended solids.
- Actual measuring value is indicated with an arrow that moves up and down to the left of the Y-scale axis.
- Samples that are not within the chosen scale of the active sensor are not displayed on the calibration screen. However, these samples are still used in the calculations. If you want to see a point outside the sensor scale, then you may temporarily change the scale in the sensor menu.

If the sample values are switched or the lab result is incorrectly performed, then the calibration curve will be incorrect. Such a mistake is easy to discover on the calibration screen since a part of the calibration curve will go in the wrong direction. Different measuring values should never correspond to the same consistency / suspended solids.

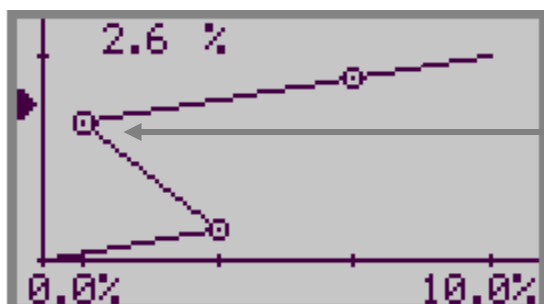

Incorrect calibration!



The curve goes backwards because two samples have been exchanged when entering the lab results. Higher Y-value must mean higher X-value. The curve must have a direction upwards and to the right.

Automatic adjustment of the calibration



The function "Adjust" in the calibration menu is used to automatically adjust the calibration in an easy way. When a sample is taken to be analyzed by lab, BB2 stores the reading. When the sample has been analyzed, the result is keyed in to the BB2 who will compare it to the stored reading and calculate a new setting for the sample value. Automatic adjustment only works for single point calibrations and is primarily intended as an easy way to get started with a new sensor. Once the automatic adjustment is done, and the sensor gives a sensible reading, we recommend using a statistical adjustment to get a higher accuracy over time, see below.

Running an automatic adjustment:

Fill a bucket with a sample of the liquid you intend to measure. Submerge the sensor into the liquid. Even though the sensors have daylight-filters they are sensitive to the infrared parts of the sunlight. Always cover the sensor and the bucket before calibration.



Select the sensor to be calibrated in the menu by using  or  arrows

Press ENTER for approximately five seconds to enter the sensor menu.

Use  and  arrows to select "Calibrate" and select "Adjust", and then "Store".



Select "Take sample" and stir the sample in the bucket until the measuring is finished.

- Replace the rod/sensor in the SS mounting bracket so the sensor is at least 12" (36 cm) below the lowest liquid level in the basin. Take the bucket to the lab for analysis. Note the concentration of the sample determined at the lab.

Use  and  arrows to select "Calibrate" and select "Adjust", and then "Lab". Press ENTER.

Press ENTER to use the stored reading , or  to key in a value.

Key in the result of the lab analyze, then press ENTER.

BB2 will show current and suggested new value for "Sample 1", acknowledge the change by pressing ENTER or abort using  or .

Getting good measurement



Statistic adjustment of the lab sample value is a much better way to good measurement than frequent calibration. This is done comparing the lab results with the instrument reading over time. If a systematic discrepancy is detected, the value of the lab sample used in BB2 is changed accordingly. If for example several lab results for a period of time in average shows 5% more than the instrument, the sample value in BB2 shall be increased 5% of its value, e.g. if the sample value is 10000 mg/l it shall be changed to 10500. Using statistic method will increase the accuracy and reliability of the measurement as time passes while new calibrations will start from scratch. An Excel sheet to help doing statistical adjustment of the calibration can be downloaded from <https://www.cerlic.com>

Zero Calibration

The sensor is zero calibrated at the factory, and does not often need to be zero calibrated. Before doing a zero calibration, always check that it is really needed. Make sure the lenses are clean, and use clean de-aerated water to check the meter reading. Cover the bucket to avoid direct sun light. Tap water is best de-aerated by leaving the water in an open bucket for at least two hours.

Running a zero calibration:

Remove the sensor from the process, clean the sensor head, and dip it in a bucket of clean water. Even though the sensors have daylight-filters they are sensitive to the infrared parts of the sunlight. Always cover the sensor and the bucket before calibration.

Select the sensor to be calibrated in the menu by using  or  arrows

Press ENTER for approximately five seconds to enter the sensor menu.

Select “Calibrate” and select “Take sample”. Press ENTER.



- Select “Zero” and press ENTER.
- To acknowledge that you really want to change the zero calibration, select “Yes” and then press ENTER.
- BB2 will ask you to put the sensor in clean water. Submerge the sensor head into the clean water and cover it from direct sunlight, then press ENTER.
- Wait for the zero calibration to finish. It will take approximately thirty seconds before the unit returns to the menu.

Detailed procedures for navigating the BB2 software can be found in the BB2 service manual.

Calibration with samples

Calibration with sample in a bucket

Fill a bucket with a sample of the liquid you intend to measure. Submerge the sensor into the liquid. Even though the sensors have daylight-filters they are sensitive to the infrared parts of the sunlight. Always cover the sensor and the bucket before calibration.

- Select the sensor to be calibrated in the menu by using  or  arrows
- Press ENTER for approximately five seconds to enter the sensor menu.
- Select “Calibrate”
- Select “Take sample”. and select “#1”
- Press ENTER and stir the sample in the bucket until the calibration is finished. It will take approximately thirty seconds.
- Replace the rod/sensor in the SS mounting bracket so the sensor is at least 12” (36 cm) below the lowest liquid level in the basin. Take the bucket to the lab for analysis. Note the concentration of the sample determined at the lab.
- Enter sample #1 concentration by going to Sample #1 in the calibration menu and pressing ENTER. Use the arrows to change the values and ENTER to go to the next digit.

- Some special applications may need additional sample points. Do not enter samples that are identical in concentration or less than 10% from initial values.

Calibration of submersible sensor in a basin or channel Calibration can be done without the use of a bucket. Make sure that the sensor is at least 30 cm below the lowest liquid level. Follow the above procedure, while the TSS is calibrating, grab a sample of the liquid with a dip bucket to take to the lab for analysis. Make sure to grab a sufficiently large sample volume for low solids applications.

Calibration of Inline sensor in a pipe

Inline sensors are easiest calibrated if the pipe has a sample outlet. Follow the above procedure, while TSS-IL is calibrating, open the sample valve and fill a bucket with process liquid. Take the bucket to the lab for analysis. Note the concentration of the sample determined at the lab.

11. Scaling

The “Scale / Alarm” menu (see the BB2 manual) allows the user to set the high and low boundaries for a 4-20mA output signal. In addition, this menu allows the user to set high and low alarm values to energize a relay when solids have reached critical points.

Max sets the 20 mA point output

Min sets the 4 mA point output (may be negative for special applications)

Hi-Alarm sets the High Alarm set point, the value zero inactivates the alarm

Low-Alarm sets the Low Alarm set point, the value zero inactivates the alarm

12. Sensor display

By simultaneously pressing  and ENTER you alter between BB2 main menu and the sensor information display for the selected sensor. TSS has a information display, it shows the sensor’s calibration curve.

13. Technical description

TSS 20

P/N	11305455
Material	316SS (SIS2343)
Dimensions	See section 14.
Weight	1,6 kg (3,5 lbs)
Process connection	Submerged
Max Depth	10 m (33 ft)
Max temperature	60°C (140°F)
Measuring principle	Straight transmission, 20 mm measuring line
Measuring range	Min 0-100 mg/l Max 0 – 20000 mg/l (application dependent)
Cable, connection	5-pin M12-plug
Cable, length	10 m (33 ft)
Cable, material	Hytrel
Flushing	Clean water or instrumentation air.
Flushing, Pressure	max 6 bar (90 psi)
Flushing hose, length	10 m (33 ft)
Flushing hose, material	PE-LD
Enclosure	IP68 NEMA 4X

TSS IL 15/34

P/N	11305630
Material	SIS2343 (316SS)
Dimensions	See section 14.
Weight	Sensor 2,4 kg (5.25 lbs) Valve 2,2 kg (4.8 lbs)
Process connection	Inline sensor, 1½” ball valve
Max process pressure	6 bar (90 psi) (10 bar (150 psi) with plugged flushing nozzle)
Max process temperature	60°C (140°F)
Measuring principle	Straight transmission, 15 mm measuring line
Measuring range	Min 0-100 mg/l Max 0 – 5 % TS (application dependent)
Cable, connection	5-pin M12-plug
Flushing	Clean water or instrumentation air.
Flushing, Pressure	2 bar (30 psi) above process pressure, max 8 bar (120 psi).
Enclosure	IP65 NEMA 4

Certificate of conformity:

The TSS sensors along with their central unit BB2 are in conformance with the following EC Directive(s) when installed in accordance with the installation instructions contained in the product documentation:

73/23/EEC Low Voltage Directive as amended by 93/68/EEC
89/336/EEC EMC Directive as amended by 92/31/EEC and 93/68/EEC

The following standards and/or technical specifications have been applied:

EN 61000-6-4:2001 Electromagnetic compatibility (EMC) Part 6-4
Generic standards – Emission standard for industrial environments

EN 61000-6-2:2001 Electromagnetic compatibility (EMC) Part 6-2
Generic standards - Immunity for industrial environments

EN 61010-1:2001 Safety requirements for electrical equipment for measurement, control, and laboratory use

14. Dimensions

TSS 20

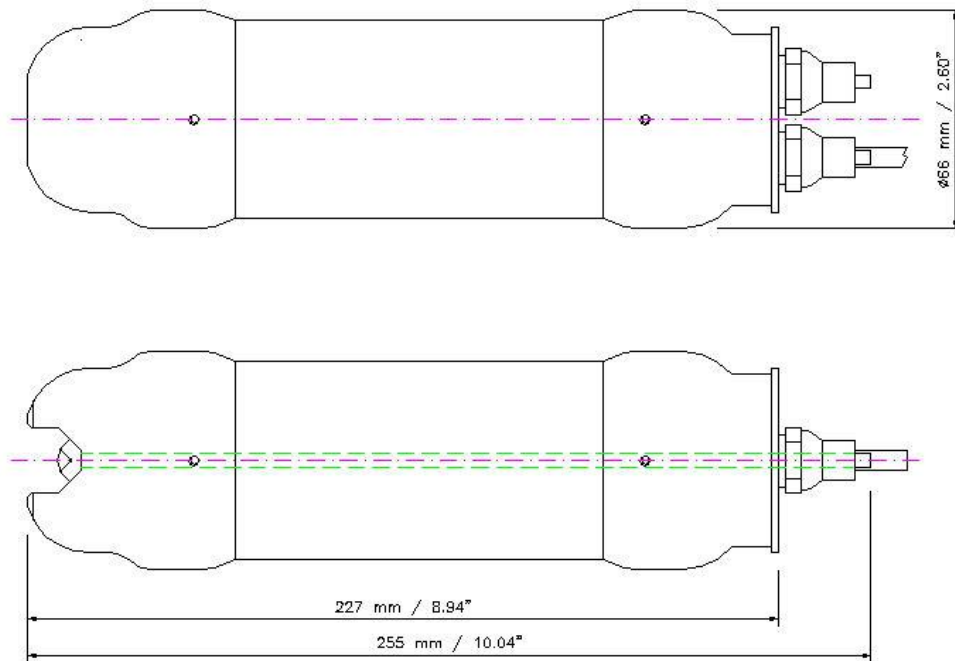

TSS-IL 15/34

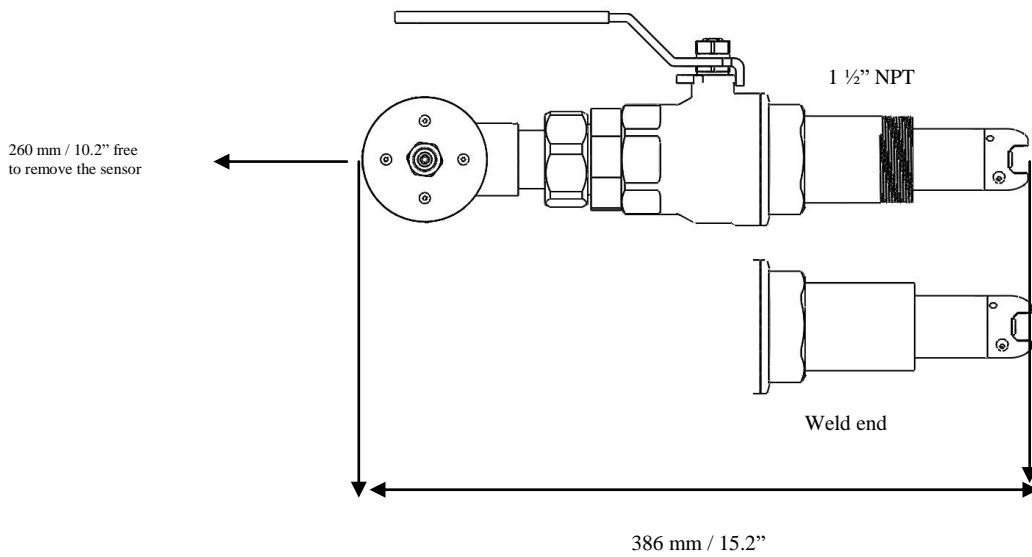

Appendix 1, Assembly of handrail mounting kit

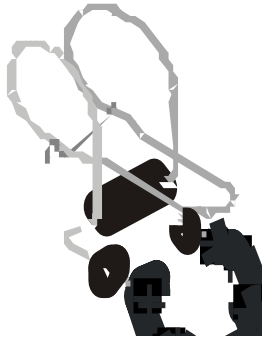

Mount the Flexible Mounting Bracket on existing handrail or on separate holder, diameter 32-50 mm (1 ¼” – 2”) or square 28-42 mm (1 ⅛” – 1 ⅝”). The bent lip on the mounting plate shall be on top and faced toward the liquid or tank. Adjust the Mounting Bracket to the correct angle and tighten the nuts. The bracket shall be fixed to the rail, and must not be able to rotate around it.

Example of a holder to be used for the mounting bracket when no handrail is available.

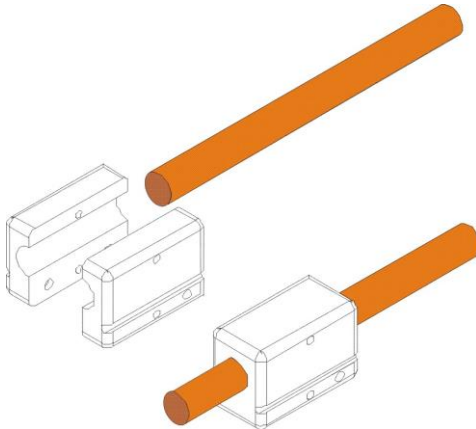
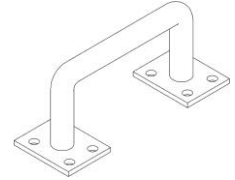

- Disassemble the bracket guide and place around the telescopic rod.
- Use the SS screws on bracket to tighten the bracket to the rod.



- Pull the cable and hose through the sensor holder and rod.
- Connect the telescoping fiberglass rod to the sensor with the two piece black PVC adapter.
- The adapter halves should be tightened until snug, which will leave about 1.5 mm (1/16”) gap. **NOTE!** The gap is required so the water can drain from the rod.
- Adjust the length of the telescopic sensor rod as necessary by twisting the nuts while holding the rod.
NOTE! Do not extend the rod sections beyond the black lines. This could lead to rod damage.

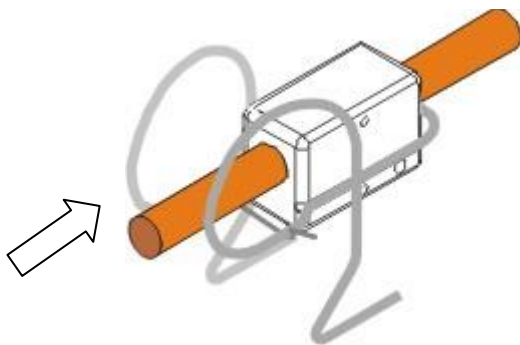

- Insert the PVC bracket guide with the telescopic rod into the mounting bracket. Make sure that the bracket guide tracks are properly seated in the bracket.
- Fasten the safety-locking clamp.
- Check that the bracket is safely fixed to the rail for the spring to work the way it is intended.
- To make it possible to inspect and service the instrument, wind up a couple of meters of the cable and fasten it on the rail with attached cable tie.
- Hint when you want to lift up the sensor; let the rod hang freely and lift it straight up before you swing it over the rail.

Appendix 2, Assembly of adjustable slide rail

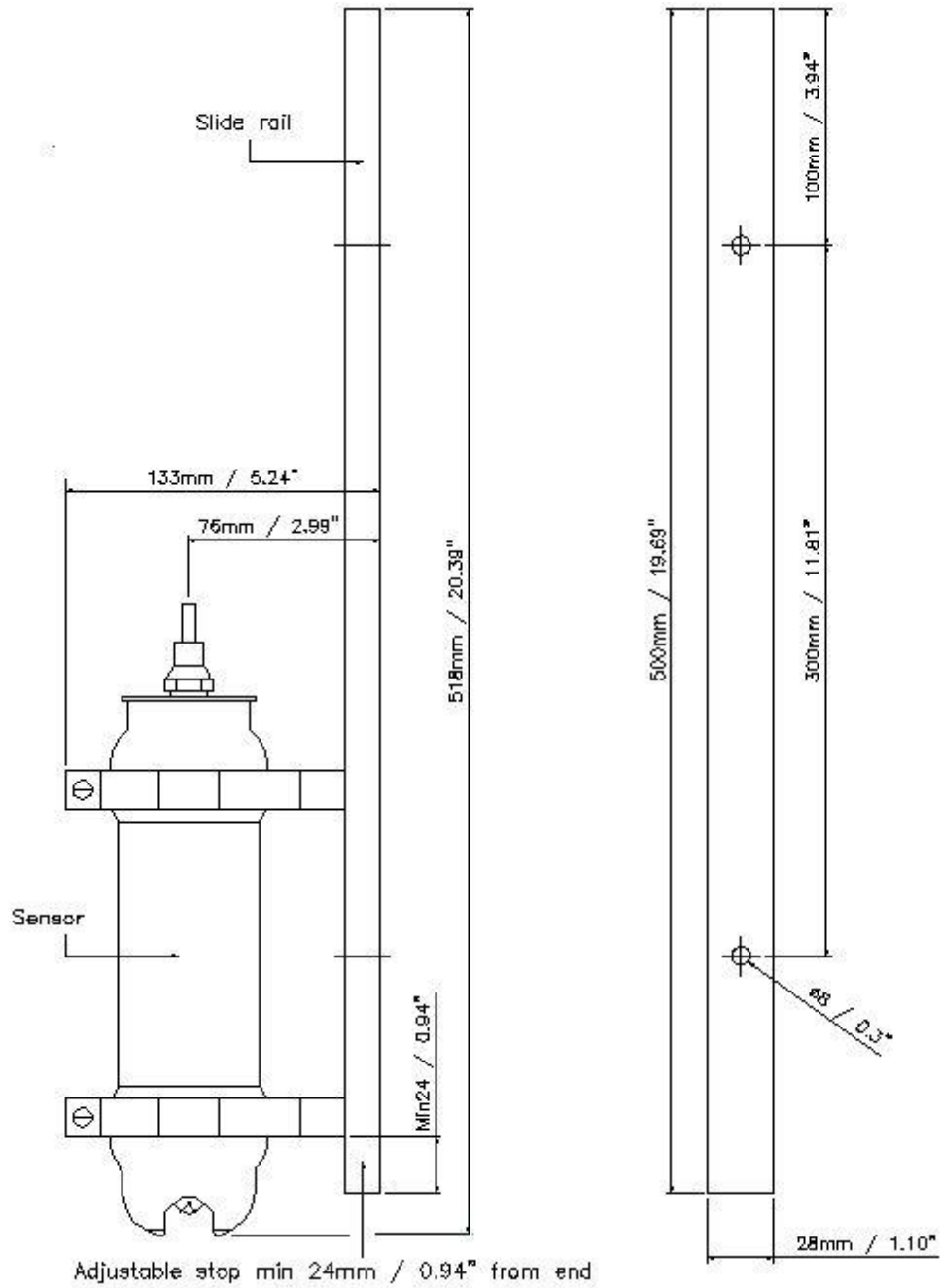

Appendix 3, Assembly of TSS-IL

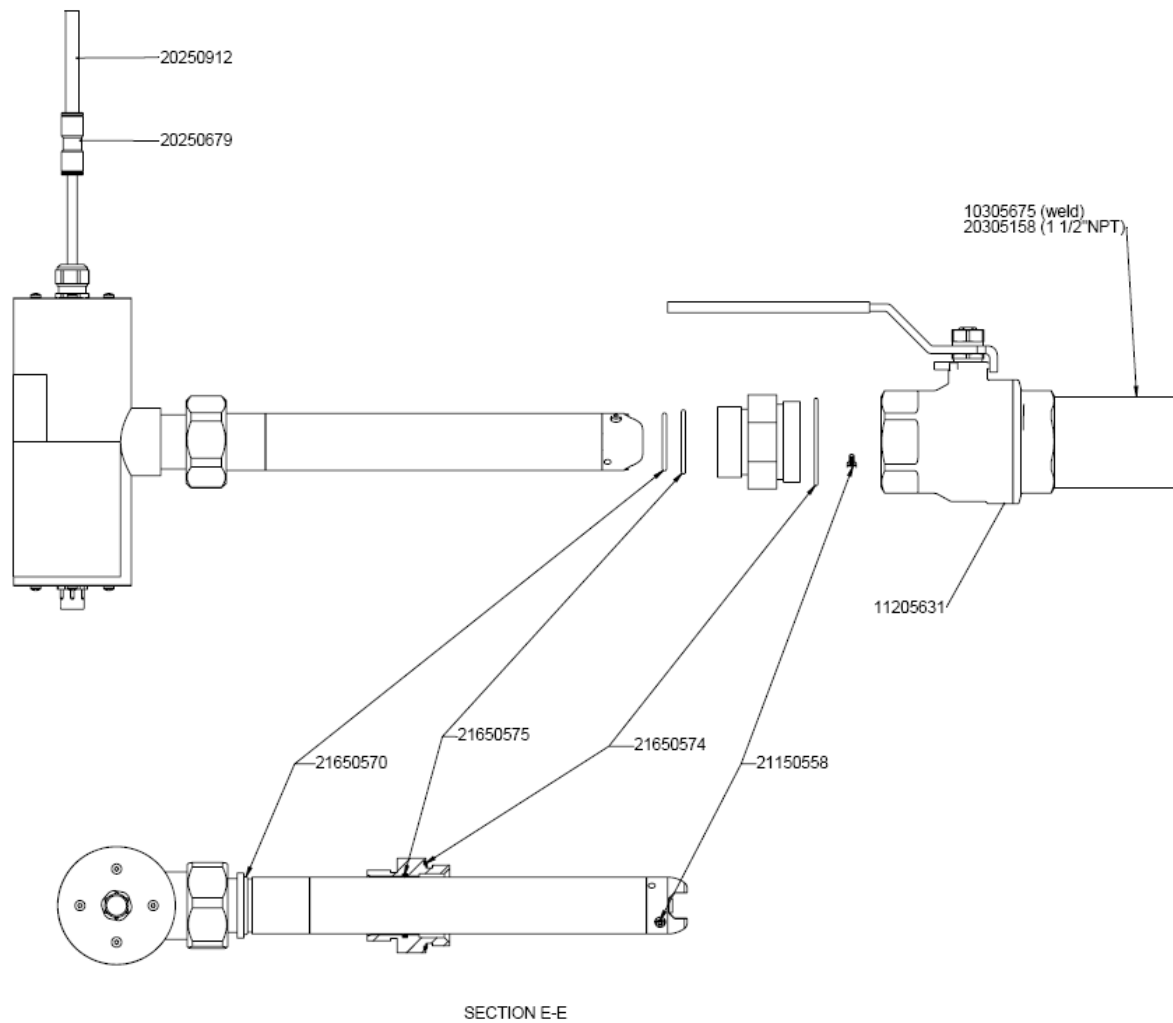

Nipple 10305675 is to be cut to make the bottom of the measure gap be at least 5 mm (1/4") from the pipe wall.

Appendix 4, Support information

Before calling Cerlic Support, please collect the information in this form and have it at hand.

Company _____

Name _____

Phone _____

E-mail _____

Sensor Type _____



Position / Tag _____

First go to the BB2 menu, it is accessed by pressing  and ENTER at the same time for five seconds. Select “System” and press.

Version _____

Serial _____

Box temp _____

Leave the BB2 menu by pressing  and ENTER at the same time. Use  or  to select the sensor in the main display. Go to the sensor menu, it is accessed by pressing ENTER for five seconds. Select “System” and press ENTER.

Type _____

Serial _____

SoftW _____

Temp _____

Select “Samples”, then press “ENTER” to go to the “Samples” sub menu.

SA 0 _____

SA 1 _____

Cons 1 _____

SA 2 _____

Cons 2 _____

SA 3 _____

Cons 3 _____

SA 4 _____

Cons 4 _____

SA 5 _____

Cons 5 _____

Return to the “System” menu. Select “Info”, then press “ENTER” to go to the “info” menu.

- MS** _____
- Con** _____
- SA0** _____
- SA1** _____
- Cons 1** _____
- Ch1a** _____
- Ch1** _____
- Intensity** _____
- Zero Int** _____
- I-offset** _____

Leave the BB2 menu by pressing  and ENTER at the same time.

Appendix 5, Setup information

This sheet can be used to document the setup of a sensor.

Sensor Type _____

Position / Tag _____

In the System sub menu of the sensor menu the following information can be collected.

Serial _____

SoftW _____

In the Settings sub menu of the sensor menu the following parameters can be set.

I-time _____

Unit _____

Analog _____

Second _____

In the Cleaning sub menu of the sensor menu the following parameters can be set.

Cleaner _____

Cleaning interval _____

Cleaning length _____

Cleaning relay _____

In the Scale / Alarm sub menu of the sensor menu the following parameters can be set.

Max _____

Min _____

High alarm _____

Low alarm _____

Alarm Relay _____

Leave the BB2 menu by pressing  and ENTER at the same time.